

iCOM

**SmarTrunk II™
Compatible**

INSTRUCTION MANUAL

VHF TRANSCEIVER

IC-F31GT/GS

UHF TRANSCEIVER

IC-F41GT/GS



Icom Inc.

FOREWORD

Thank you for purchasing the IC-F31GT/GS, IC-F41GT/GS FM transceiver.

READ ALL INSTRUCTIONS carefully and completely before using the transceiver.

SAVE THIS INSTRUCTION MANUAL—This instruction manual contains important operating instructions for the transceiver.

ABOUT CE



CE Versions of the IC-F31GT/GS, IC-F41GT/GS which display the “CE” symbol on the serial number seal, comply with the essential requirements of the European Radio and Telecommunication Terminal Directive 1999/5/EC.

This warning symbol indicates that this equipment operates in non-harmonised frequency bands and/or may be subject to licensing conditions in the country of use. Be sure to check that you have the correct version of this radio or the correct programming of this radio, to comply with national licensing requirements.

INSTALLATION NOTES

- When transmitting with a portable radio, hold the radio in a vertical position with its microphone 5 to 10 centimeters away from your mouth. Keep the antenna at least 2.5 centimeters from your head and body.
- If you wear a portable two-way radio on your body, ensure that the antenna is at least 2.5 centimeters from your body when transmitting.

IMPORTANT

⚠ **CAUTION! NEVER** hold the transceiver so that the antenna is very close to, or touching exposed parts of the body, especially the face or eyes, while transmitting. The transceiver will perform best if the microphone is 5 to 10 cm away from the lips and the transceiver is vertical.

⚠ **CAUTION! NEVER** operate the transceiver with a headset or other audio accessories at high volume levels.

⚠ **CAUTION! NEVER** short the terminals of the battery pack.

DO NOT push the PTT when not actually desiring to transmit.

AVOID using or placing the transceiver in direct sunlight or in areas with temperatures below -10°C or above $+50^{\circ}\text{C}$.

The basic operations, transmission and reception of the transceiver, are guaranteed within the specified operating temperature range (depending on version). However, the LCD display may be operate correctly, or show an indication in the case of long hours of operation, or after being placed in extremely cold areas.

DO NOT modify the transceiver for any reason.

KEEP the transceiver from the heavy rain, and **Never** immerse it in the water. The transceiver construction is **water resistant**, not waterproof.

The use of non-Icom battery packs/chargers may impair transceiver performance and invalidate the warranty.

TABLE OF CONTENTS

ABOUT CE	i
INSTALATION NOTES	i
FOREWORD	i-ii
IMPORTANT	ii
TABLE OF CONTENTS	iii
1 ACCESSORIES	1
2 PANEL DESCRIPTION	2-4
■ Switches, controls, keys and connectors	2-3
■ Function display	4
3 BATTERY PACKS	5-10
■ Battery pack replacement	5
■ Battery cautions	6
■ Battery charging	7-8
■ Charging NOTE	9
■ Battery case (Option)	10
4 PROGRAMMABLE FUNCTIONS	11-15
■ General	11
5 CONVENTIONAL OPERATION	16-18
■ Receiving and transmitting	16
■ Call procedure	17
■ Tx code channel selection	18
■ Manual 5-tone codes	18
■ Transmitting notes	18
6 SmarTrunk II™ OPERATION	19-21
■ Basic operation	19
7 OTHER FUNCTIONS	22
■ DTMF pager/Code squelch	22
8 OPTIONAL UNIT INSTALLATION	23
■ Installation	23
9 CLONING	24
10 OPTIONS	25-26
■ Options	25-26
11 MEMO	27

■ Accessory attachment

◇ Supplied accessories

The transceiver comes supplied with the following accessories.

- ① Flexible antenna (may differ from that shown, or may not be supplied with some versions)

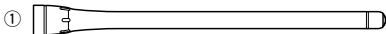

- ② Belt clip

◇ Antenna

The antenna screws onto the transceiver as illustrated at right.

✓ For IC-F31GT-L/GS-L

The most suitable flexible antenna should be purchased according to programmed frequency parameters. See page 26 for details.

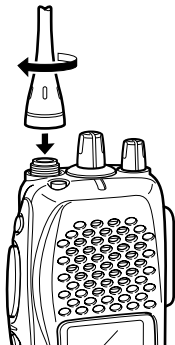

◇ Belt clip

Attach the belt clip to the transceiver as illustrated below.

To attach the belt clip

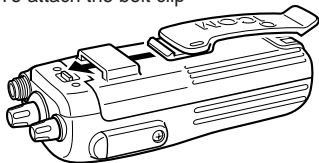

To release the belt clip

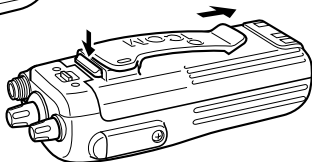

2 PANEL DESCRIPTION

■ Switches, controls, keys and connectors

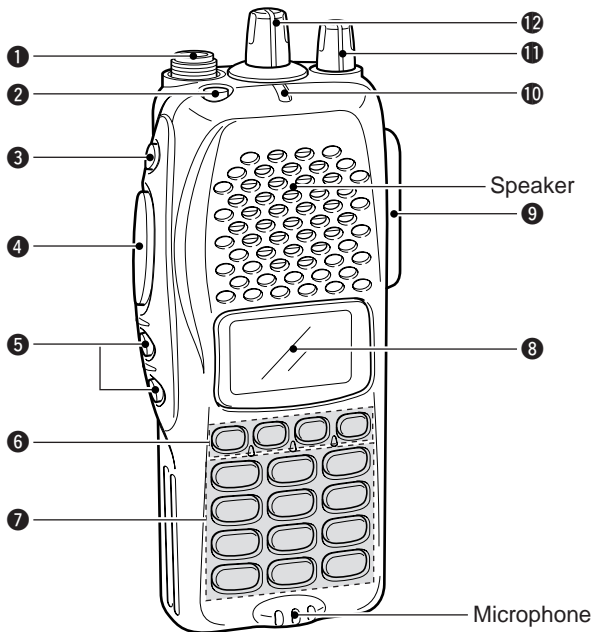

◇ Programmable key reference

F0 (Red)		P ₀	
F1 (Black)		P ₁	
F2 (Black)		P ₂	
F3 (Black)		P ₃	

1 ANTENNA CONNECTOR

Connects the supplied antenna.

2 DEALER-PROGRAMMABLE KEY [F0 (Red)]**3 DEALER-PROGRAMMABLE KEY [F1 (Black)]****4 PTT SWITCH [PTT]**

Push and hold to transmit; release to receive.

5 DEALER-PROGRAMMABLE KEYS [F2 (Black)], [F3 (Black)]

- Push to select the operating channel. Depends on setting.
- Can be programmed as [*]/[#]. (SmarTrunk mode only)

6 DEALER-PROGRAMMABLE KEYS [P₀]/[P₁]/[P₂]/[P₃]

Can each be programmed for one of several functions by your Icom Dealer.

7 10-KEY PAD (IC-F31GT/IC-F41GT only)

Used to enter DTMF codes, the operating channel, etc.

8 FUNCTION DISPLAY

Displays a variety of information, such as, operating channel number/names, 5-tone code, remaining battery power, DTMF numbers, transmit output power setting, Audible indication, etc.

/// **NOTE:** The above functions depend on pre-setting.

9 MULTI CONNECTOR

Connect optional speaker-microphone, etc..

10 TRANSMIT/BUSY INDICATOR

Lights red while transmitting; lights green while receiving a signal, or when the squelch is open.

11 VOLUME CONTROL [VOL]

Turns power ON and adjusts the audio level.

12 ROTARY SELECTOR [SEL]

Selects operating channel, or bank. Depends on setting.

■ Function display

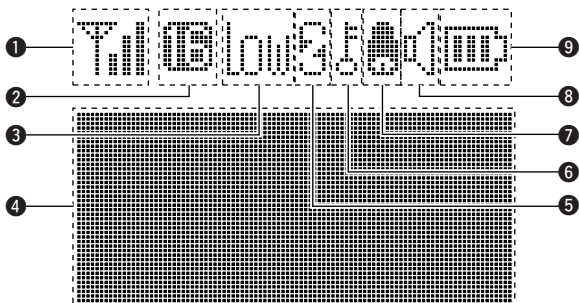

① SIGNAL STRENGTH METER

Indicates relative signal strength level.

② BANK NUMBER INDICATOR

Indicates operating bank (channel group) number.

③ LOW POWER INDICATOR

Appears when low output power is selected.

④ MULTI-FUNCTION INDICATOR

Indicates operating channel number, channel names, 5-tone code, etc., according to operating condition.

⑤ SCRAMBLER INDICATOR

Appears while the voice scrambler function is activated.

⑥ KEY LOCK INDICATOR

Appears during key lock function ON.

⑦ BELL INDICATION

Appears or blinks when a 2/5Tone call is received.

⑧ AUDIBLE INDICATOR

Appears when the monitor function is turned ON. (CTCSS and DTCS mutes are released.)

⑨ BATTERY INDICATOR

Indicates remaining battery power.

■ Battery pack replacement

Before replacing the battery pack, the volume control **MUST** be rotated fully counterclockwise, until a click is heard, to turn the power OFF.

- Slide the battery release forward, then pull the battery pack upward with the transceiver facing away from you.

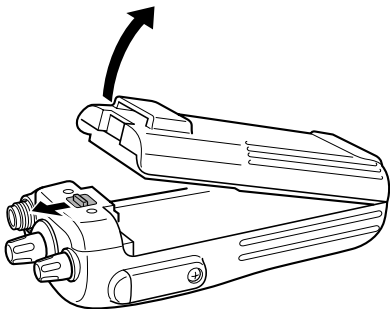

◇ BATTERY PACKS

Battery pack	Voltage	Capacity	Charging period		Battery life*1
			BC-137	BC-144 or BC-121 with AD-94	
BP-208	Battery case for AA (R6)×6 alkaline		N/A	N/A	—*2
BP-209	7.2 V	1100 mAh	15 hrs.	1.5 hrs.	7 hrs.
BP-210	7.2 V	1650 mAh	15 hrs.	2.0 hrs.	11 hrs

*1 Battery life is calculated under the following conditions;

Tx : Rx : standby = 5 : 5 : 90

*2 Operating period depends on alkaline cells used.

■ Battery cautions

- **CAUTION! NEVER** short terminals (or charging terminals) of the battery pack. Also, current may flow into nearby metal objects such as a necklace, so be careful when placing battery packs (or the transceiver) in handbags, etc.
Simply carrying with or placing near metal objects such as a necklace, etc. causes shorting. This will damage not only the battery pack, but also the transceiver.
- **NEVER** incinerate used battery packs. Internal battery gas may cause an explosion.
- **NEVER** immerse the battery pack in water. If the battery pack becomes wet, be sure to wipe it dry **BEFORE** attaching it to the transceiver.
- **Clean** the battery terminals to avoid rust or miss contact.
- **Keep** battery contacts clean. It's a good idea to clean battery terminals once a week.

If your battery pack seems to have no capacity even after being charged, completely discharge it by leaving the power ON overnight. Then, fully charge the battery pack again. If the battery pack still does not retain a charge (or only very little charge), a new battery pack must be purchased. (p. 9)

■ Battery charging

◇ Rapid charging with the BC-144

The optional BC-144 provides rapid charging of optional battery packs.

The following are additionally required:

- One AD-99 (supplied with the BC-144; AD-97 supplied versions are also available).
- An AC adapter (may be supplied with the BC-144 depending on version).

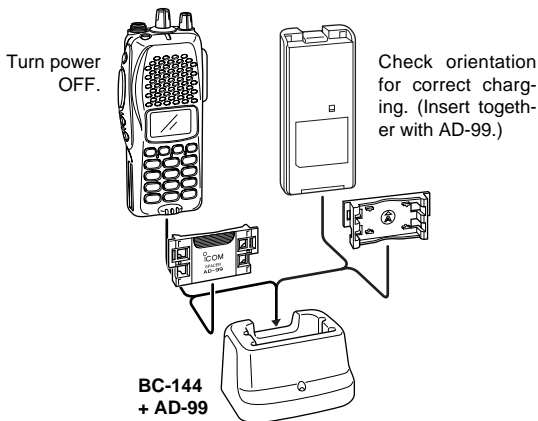

/// The BC-144 cannot be used in a vehicle, because the charger requires 16 V DC input.

AD-99— Use Spacer A only!

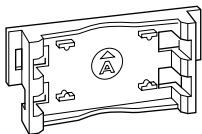

The adapter (Spacer A) only is required for charging a battery pack with the IC-F30G series transceiver. See BC-144 instruction manual for details.

3 BATTERY PACKS

◇ Rapid charging with the BC-121+AD-94 #11

The optional BC-121 allows up to 6 battery packs to be charged simultaneously. The following are additionally required.

- Six AD-94 (#11).
- An AC adapter (may be supplied with the BC-121 depending on version).

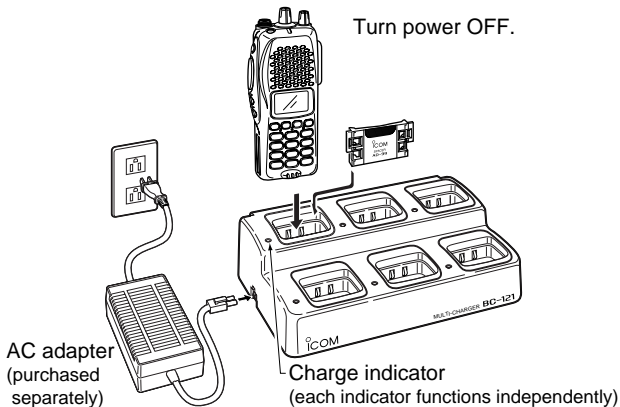

◇ Regular charging with the BC-137 #11/BC-146

The optional BC-137 #11 or BC-146 provides regular charging of optional battery pack with/without transceiver. The following is additionally required:

- An optional AC adapter. (AD-99 is supplied with BC-137 #11/BC-146)

Turn power OFF.

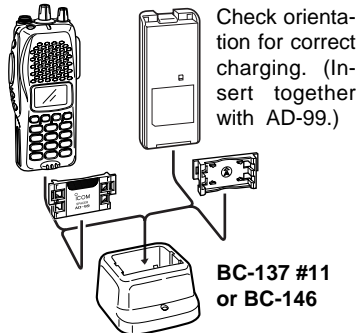

■ Charging NOTE

Prior to using the transceiver for the first time, the battery pack must be fully charged for optimum life and operation.

- Recommended temperature range for charging:
+10°C to +40°C
- Use the supplied charger or optional charger (BC-119/BC-121/BC-144 for rapid charging, BC-137 #11/BC-146 for regular charging) only. **NEVER** use other manufacturers' chargers.

The optional BP-209 or BP-210 battery packs include rechargeable Ni-Cd (Ni-MH: BP-210) batteries and can be charged approx. 300 times. Charge the battery pack before first operating the transceiver or when the battery pack becomes exhausted.

If you want to charge the battery pack more than 300 times, the following points should be observed:

- Avoid over charging. The charging period should be less than 48 hours.
- Use the battery until it becomes almost completely exhausted under normal conditions. We recommend battery charging after transmitting becomes impossible.

◆ Battery pack life

When the operating period becomes extremely short even after charging the battery pack fully, a new battery pack is needed.

■ Battery case (Option)

When using an optional BP-208 BATTERY CASE attached to the transceiver, install 6 AA (R6) size alkaline batteries as illustrated below.

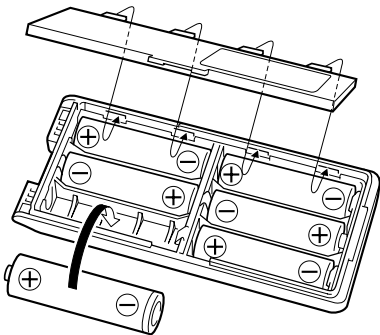

◇ CAUTIONS

- Use **ALKALINE** batteries only.
- **Make sure** all battery cells are the same brand, type and capacity.
- **Never** mix old and new batteries.

Either of the above may cause a fire hazard or damage the transceiver if ignored.

- **Never** incinerate used battery cells since internal battery gas may cause them to rupture.
 - **Never** expose a detached battery case to water.
- If the battery case gets wet, be sure to wipe it dry before use.

■ General

In the following explanations, programmable function names are bracketed, the specific switch used to activate the function depends on programming.

◇ KEYPAD LOCK FUNCTION

This function locks access to all programmable switches (except the switch assigned for the lock function).

Push and hold the [Lock] switch for 1 sec. to toggle the lock function ON and OFF.

- “” appears while the lock function is ON.
- This function may be inhibited on some channels.

◇ PRIORITY CHANNEL

This function is used to select a pre-programmed channel at the push of a switch.

Push the [Priority A/A (Rewrite)/B] switch to select the priority channel.

- “Prio A” or “Prio B” appears briefly, then the priority channel is automatically selected.

◇ SCAN FUNCTION

The scan function allows you to search a pre-programmed group of channels for signals.

Push the [Scan A/B] switch to start/stop scan.

- Scan pauses on a channel when receiving a signal.
- Depending on programming, a message may appear while scanning.
- “Lockout SCAN” (pre-programmed list SCAN) or “Priority SCAN” can be pre-programmed.
- When the “Power-save function” is activated, the transceiver checks all pre-programmed channels then returns to the “Power-save function” again.

4 PROGRAMMABLE FUNCTIONS

◇ HIGH/LOW POWER OUTPUT

This function selects high or low power for a channel.

Push the [High/Low] switch to change transmit output power between high, low1 and low2 power.

- “low” appears when low1 or low2 output power is selected.

◇ SCRAMBLER FUNCTION

(optional UT-109 #02* or UT-110 #02* is required.)

This function provides higher communication security.

UT-109: Non-rolling type. 32 code numbers are available.

UT-110: Rolling type. 1020 (4 group × 255) code numbers are available.

Push the [Scrambler] switch to toggle the function ON and OFF.

 **NOTE: NEVER use #01** Low AF level versions, as they are not compatible

◇ MONITOR AUDIBLE FUNCTION

The monitor function allows you to open the transceiver's squelch manually to check whether a channel is busy or not. The transceiver has 2 conditions for receive standby:

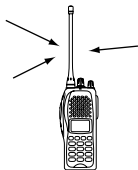

All signals are received.

Audible condition:

This condition mutes audio ONLY when no carrier is present. You can receive (or monitor) any signals on a channel.

- Push and hold the [Moni (Audi)], switch to select the audible condition.

Any audio mute functions are cancelled while pushing the [Moni (Audi)] switch.



Only signals containing the proper tone are received.

Inaudible condition:

This condition mutes ALL signals except those directed to you. Therefore you should check a channel's condition (busy or not) with the monitor function before transmitting.

- Push the [Moni (Audi)], switch momentarily to select the inaudible condition.

◇ TALK AROUND

The talk around function changes duplex channels to simplex channels.

- **Duplex** allows you to contact your base station, repeaters, etc.
- **Simplex** allows you to contact other portable transceivers directly (portable-to-portable contact).

Push the [Talk Around] switch to toggle the function ON and OFF.

4 PROGRAMMABLE FUNCTIONS

◇ DTMF TRANSMISSION

This function allows you to send a pre-programmed DTMF code to control a repeater, open another transceiver's squelch, etc.

Manual transmission:

Push desired digit keys in sequence while pushing [PTT].

- Pushing [PTT] may not be necessary depending on programming.

Automatic pre-programmed transmission:

- ① Push the [DTMF Autodial] switch to select DTMF autodial mode, then push [CH Up] or [CH Down] to select the desired channel.
- ② Push the [DTMF Autodial] switch to send a DTMF code.

◇ DTMF RE-DIAL FUNCTION

This function allows you to transmit the last-used DTMF code at the push of a key.

Push the [Re-dial] switch momentarily to activate the function.

- The previously transmitted DTMF code is automatically transmitted.
- If no code has been transmitted since turning the power ON, this function does not activate.

◇ EMERGENCY FUNCTION

The emergency function allows you to send an emergency signal quickly and easily to your Base Station, etc. in case of emergency.

Push and hold the [Emergency Single/Repeat] switch for 1 sec. to activate the emergency function.

- The transceiver selects a pre-programmed channel, then sends an emergency signal to your Base Station.
- The pre-programmed channel remains selected until a control signal is received from the Base Station, or power is turned OFF.
- The emergency call is repeatedly transmitted at pre-programmed intervals.

◇ DISPLAY LIGHTING

The function display has 3 backlight conditions.

ON : Backlight turns ON continuously.

OFF : No backlight is available.

AUTO : When any key is pushed, the backlight turns ON for 5 sec. automatically.

◇ SmarTrunk II™ functions

This transceiver provides SmarTrunk II™ functions.



(Optional UT-105 SmarTrunk II™ Logic Board is required.)

The optional UT-105 allows communication over conventional channels or SmarTrunk II™ channels. Select a channel bank for SmarTrunk II™ before trunking operation.

To toggle SmarTrunk II™ channels and conventional channels, push the [Bank] switch one or more times.

- Scanning starts when a channel bank for SmarTrunk II™ is selected.
- Contact your dealer for channel bank details.
(See p. 21 for more detailed operation.)

■ Receiving and transmitting

-  **NOTE:** Transmitting without an antenna may damage the transceiver. See p. 1 for antenna attachment.
-  Turn power ON as described on p. 1.

Receiving:

- ① Push [CH Up]/[CH Down], or rotate [SEL] to select a channel.
- ② Listen for a transmission and adjust [VOL] to a comfortable listening level.
 - When no transmission is heard, push and hold monitor while adjusting [VOL] (your transceiver may not be programmed with the monitor function).

The transceiver is now set to receive desired calls on the selected channel.

Transmitting:

Wait for the channel to become clear to avoid interference.

- ③ While pushing and holding [PTT], speak into the microphone at a normal voice level.
 - When a tone signalling system is used, the call procedure described at right may be necessary.
- ④ Release [PTT] to return to receive.

IMPORTANT: To maximize the readability of your transmitted signal, pause a few seconds. After pushing [PTT], hold the microphone 5 to 10 cm from your mouth and speak at a normal voice level.

■ Call procedure

When your system employs tone signalling (excluding CTCSS and DTCS), the call procedure may be necessary prior to voice transmission. The tone signalling employed may be a selective calling system which allows you to call specific station(s) only and prevent unwanted stations from contacting you.

- ① Select the desired Tx code channel or 5-tone code according to your System Operator's instructions.
 - This may not be necessary depending on programming.
 - Refer to the next page for selection.
- ② Push the call switch (assigned to one of the dealer programmable switches: [P₀], [P₁], [P₂], [P₃], [F2] and [F3]).
- ③ After transmitting a 5-tone code, the remainder of your communication can be carried out in the normal fashion.

Selective calling

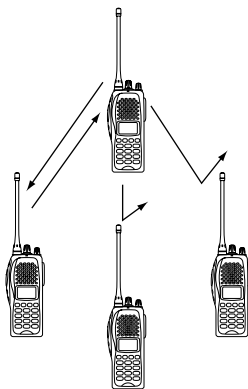

Non-selective calling

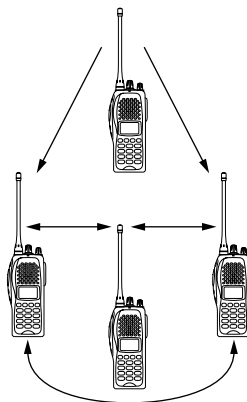

■ Tx code channel selection

Your radio may be programmed for Tx code channel selection. In this case, you can choose a Tx code channel to be transmitted when using the call function (p. 17).

Push [Tx Code CH Up/Down] (assigned to one of the dealer-programmable switches) to select the desired Tx code channel.

- The selected code channel (containing a pre-programmed 5-tone code) is transmitted when using the call function.

■ Manual 5-tone codes

Depending on programming, you may be able to send 5-tone codes manually.

Push [Tx Code] to activate the function, then enter the desired transmit code (up to 7 digits) using the keypad.

- Activate the call function to transmit the 5-tone code.
- Blinking indicates keypad entry is acceptable.

■ Transmitting notes

◇ TIME-OUT TIMER

After continuous transmission for a pre-programmed period, the time-out timer is activated, causing the transceiver to stop transmitting.

◇ PENALTY TIMER

Once the time-out timer is activated, transmission is further inhibited for a period determined by the penalty timer.

■ Basic operation

These features are enabled by your Dealer or System operator and may not be available in your system. Contact your Dealer for details.

Push the [Bank] switch one or more times to select a channel bank for conventional channels or SmarTrunk II™ channels.

- Scanning starts when a channel bank for SmarTrunk II™ is selected.

◇ PTT dispatch operation*¹

- ① Push [PTT] once (without dialling) to initiate a dispatch call.
 - ② Begin talking after you hear three beeps (one short, high-pitched, two very-short, low-pitched).
 - ③ Receiving a dispatch call is indicated by the same three-beep sequence.
- It is not necessary to push [*] to answer a dispatch call.

◇ System busy indication

If all channels are busy, three low beeps sound after you initiate a call. Try the call again later.

◇ Receiving a subscriber-to-subscriber call*¹

When you hear ringing, push [*] to answer.

- For a group call, you hear a short ring followed by two short beeps. You do not have to answer a group call to hear it over the air.

◇ Receiving a landline-to-subscriber call*¹

When you hear ringing, push [*] to answer.

- For a group call, you hear a short ring followed by two short beeps. You do not have to answer a group call to hear it over the air.

◇ Terminating a call*¹

After completing a call, push [#] to disconnect (hang up).

IMPORTANT: If one person in the conversation terminates a call, all participants will be cut off.

6 SmarTrunk II™ OPERATION

◆ Last number redial*¹

Push [*], [*] to automatically redial the last number called.

- A high-pitched beep indicates that the number is accepted.

◆ Turbo Speedial

To automatically dial a commonly used number with one push:

- Push one of the turbo Speedial keys.

◆ Programming memory speed dial

① Push and hold [*] until you hear a high-pitched beep.

② Enter the memory location (0–9, A, B, C, D), the telephone or subscriber number, then [1], [*] (or [3], [*] if for another system subscriber).

- A high-pitched beep indicates successful programming.
- Memories [A]–[D] are used for the Turbo Speedial.

 **NOTE:** This function is available for the IC-F31GT/IC-F41GT only.

◆ Memory speed-dialling*²

To automatically dial a commonly used number from memory:

- Push [*] followed by the memory location (0–9).

◆ Clear channel alerting*¹

If all channels are busy, the transceiver automatically begins searching for an open channel and beeps every ten seconds. When two short beeps (low-pitched, then high-pitched) are heard, a channel is available. Push [*], [*] immediately to redial the last number.

◆ Emergency call*²

Push [0], [*] to initiate an emergency call.

- Contact your Dealer for details.

◇ Placing a telephone call*2

Enter the phone number followed by [1], [*].

- A high-pitched beep indicates that the number is accepted.
- When the called party answers, push the [PTT] switch to talk, and release it to listen.

◇ Calling another local system subscriber*2

Enter the subscriber number followed by [3], [*].

- A high-pitched beep indicates that the number is accepted.
- You hear ringing, then two short beeps when the subscriber answers.
- If the other subscriber is on another call or out of range, you hear a fast busy signal and the call terminates automatically.

1: This function is available for the IC-F31GS/IC-F41GS when the [F2]/[F3] keys are assigned the []/[#] key functions.

*2: This function is available for the IC-F31GT/IC-F41GT only.

Use the Turbo Speedial function instead.

For additional operating instructions, contact your Dealer or System Operator.

7 OTHER FUNCTIONS

■ DTMF PAGER/CODE SQUELCH

◇ DTMF pager

This function uses DTMF tones for calling and can be used as a “common pager” to inform you that one of your group has called even if the operator is temporarily away from the transceiver.

- When the connection code is received, a beep sounds, then “” flashes and shows the called station’s code number.
- The called station’s code number is memorised automatically, and is easy to re-call with “ID-MR select function”.

◇ Code squelch

This conveniently eliminates unwanted audio and is useful in group activities or security related activities where unwanted output can be a problem. The function is similar to a CTCSS tone squelch.

In order to use the above functions, cloning is necessary via a PC using the optional CS-F30G CLONING SOFTWARE. Using this software, the transceiver’s model, individual RX Code CH, TX Code CH, Special Tone Link2 (must be ‘E’) in 5Tone screen, 5Tone Signaling Form in Memory-CH screen, Log, RX C-No, Key&Display, Common Auto Reset Timer B, and other settings related to operation can be set. Refer to the HELP file that comes with the CS-F30G CLONING SOFTWARE for available settings.

OPTIONAL UNIT INSTALLATION 8

You can install two of the following optional units in the transceiver. UT-105 SmarTrunk II™ Logic Board, UT-109/UT-110 VOICE SCRAMBLER UNIT, UT-111 TRUNKING BOARD, UT-113 MAN DOWN UNIT.

■ Installation

- ① Unscrew nut (a), and remove the knobs.
- ② Unscrew screw (b) and 2 screws (c), then remove the multi-connector cover and rear panel.
- ③ Unscrew 2 screws (d), then remove the multi-connector.
- ④ Unscrew 2 screws (e), then take off the chassis from the front panel in the direction of the arrow.

Be careful!: Flat cable is connected between the MAIN unit on the chassis and front panel.

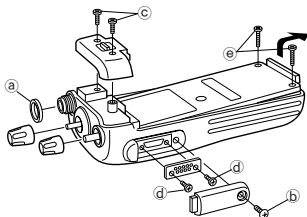

- ⑤ Install the desired optional unit. Insert tightly to avoid bad contact.

NOTE: When installing UT-105 or UT-111, the unit **MUST BE** plugged into **SLOT 1**. Otherwise the unit will not work correctly. (Other optional units can be plugged into either slot.)

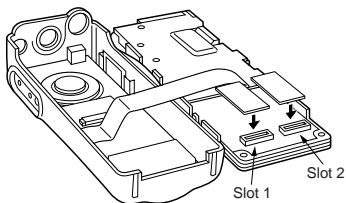

- ⑥ Program the necessary information with the cloning software before operation. Please ask your dealer or system operator for details.

9 CLONING

■ Cloning

Cloning allows you to quickly and easily transfer the programmed contents from one transceiver to another transceiver; or data from PC to a transceiver using the optional CS-F30G CLONING SOFTWARE.

◆ PC-to-transceiver cloning

Please refer to the HELP file that comes with the CS-F30G CLONING SOFTWARE.

CAUTION: Imprudent cloning operation causes a cloning error. In such a case, memory contents may be lost. Cloning must then be repeated.

◇ BATTERY PACKS

- **BP-208** BATTERY CASE

Allows a set of Alkaline batteries to operate the handheld when charging rechargeable batteries or in emergencies, etc. 6 AA (R6) alkaline cells are required.

- **BP-209** Ni-Cd BATTERY PACK

7.2 V/1100 mAh Ni-Cd battery pack, allows more than 7 hours operation.

- **BP-210** Ni-MH BATTERY PACK

7.2 V/1650 mAh Ni-MH battery pack, allows approx. 11 hours operation.

◇ CHARGER

- **BC-144** DESKTOP CHARGER + **BC-145** AC ADAPTOR

For rapid charging of battery packs. An AC adapter is supplied with the charger. Charging time: 1.5 to 2 hrs.

- **BC-137 (#11)** BATTERY CHARGER + **BC-122** AC ADAPTOR

For regular charging of battery packs. An AC adapter is additionally required. Charging time: 15 hrs.

- **BC-146** BATTERY CHARGER + **BC-147** AC ADAPTOR

For regular charging of battery packs. An AC adapter is additionally required. Charging time: 18.5 hrs.

- **BC-121** MULTI-CHARGER + **AD-94 (#11)** CHARGER ADAPTOR (6 pcs.)

For rapid charging of up to 6 battery packs (six AD-94's are required) simultaneously. An AC adapter may be supplied depending on version. Charging time: 1.5 to 2 hrs.

- **BC-119** DESKTOP CHARGER + **AD-94 (#11)** CHARGER ADAPTOR

For rapid charging of battery packs. An AC adapter is supplied with the charger. Charging time: 1.5 to 2 hrs.

◇ INTERNAL UNITS

- **UT-105** SmarTrunk II™ Logic Board

Provides SmarTrunk II™ capabilities.

10 OPTIONS

- **UT-109 #02/UT-110 #02** SCRAMBLER UNITS
Non-rolling type (UT-109)/Rolling type (UT-110) voice scrambler unit provides higher communication security.
- **UT-111** TRUNKING BOARD
Provides LTR® trunking capabilities.
- **UT-113** MAN DOWN UNIT
Provides a measure of safety when working in a hazardous environment, etc.

◇ OTHER OPTIONS

- **AD-52** EARPHONE JACK ADAPTER
Allows you to connect an earphone, 2-conductor 3.5 (d) mm (1/8").
- **AD-98FSC** ANTENNA CONNECTOR CONVERTER
Allows you to connect an external antenna with BNC connector.
- **EM-80/EM-89/HM-131SC** SPEAKER-MICROPHONES
Combination speaker-microphone that provides convenient operation while hanging the transceiver from your belt.
- **FA-SC12L/FA-SC13L** FLEXIBLE ANTENNAS
FA-SC12L: 66–76 MHz FA-SC13L: 76–88 MHz
- **FA-SC56VS/FA-SC57VS/FA-SC73US** STUBBY ANTENNAS
Shorter VHF or UHF antennas.
FA-SC56VS: 150–162 MHz FA-SC57VS: 160–174 MHz
FA-SC73US: 450–490 MHz
- **HS-94** HEADSET + **VS-1SC** VOX/PTT CASE
Ear-piece type headset and VOX/PTT switch box for hands-free operation, etc. PC programming may be required for the IC-F31G series transceivers to enable the VOX operation.
- **MB-68** BELT CLIP
Same as that supplied with the transceiver.
- **MB-74** BELT CLIP
Exclusive alligator-type belt clip.

SmarTrunk II is a trademark of the SmarTrunk System Corporation. LTR is a registered trademark of EFJohnson Radio Systems.

Count on us!

<Intended Country of Use>

- | | | |
|------------------------------|------------------------------|------------------------------|
| <input type="checkbox"/> GER | <input type="checkbox"/> NED | <input type="checkbox"/> ITA |
| <input type="checkbox"/> AUT | <input type="checkbox"/> BEL | <input type="checkbox"/> GRE |
| <input type="checkbox"/> GBR | <input type="checkbox"/> LUX | <input type="checkbox"/> SWE |
| <input type="checkbox"/> IRL | <input type="checkbox"/> ESP | <input type="checkbox"/> DEN |
| <input type="checkbox"/> FRA | <input type="checkbox"/> POR | <input type="checkbox"/> FIN |